

# MasterSheet

034 0021  
Revision 08/14/12



Complete Car Audio  
Installation Instructions  
**CRUTCHFIELD™**

**2003-'04  
Mercury Marauder**



## IMPORTANT

Before starting, compare items on your invoice with items received. Carefully check through packaging material. If any item is missing, please call **Crutchfield Technical Support at 1-800-955-9094**.

Although reasonable attempts are made to verify the accuracy of the information contained in this MasterSheet, it is presented without warranties or guarantees of any type due to the constantly changing nature of this type of information and running changes in vehicle production. Any person or entity using this information does so at his or its own risk. If you find our instructions are different from your vehicle, or if you have questions, do not continue with your installation. Contact our toll-free technical support for assistance.



\*0000340021\*

## Inside...

Page

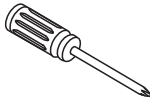
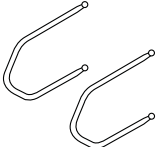
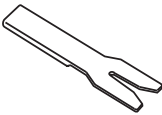
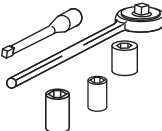
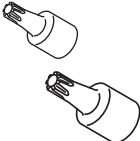
2	Factory Radio Removal		✓						
3	Receiver Installation								
4-5	Front Door Speakers	✓		✓	✓	✓			✓
6	Rear Deck Speakers	✓		✓					
7	Rear Subwoofer			✓			✓	✓	
		Phillips Screwdriver	DIN Tools	Panel Tool	5mm	7mm	12mm	T20	T30
					Socket, Ratchet & Extension			Torx Driver	
<b>Tools Required ▶</b>									

**Note:** At this time, no aftermarket antenna is available from Crutchfield. A replacement antenna may be purchased from a local dealership.

**CRUTCHFIELD®**  
CRUTCHFIELD.COM

Copyright 2012 Crutchfield Corporation

034 0021

# Factory Radio Removal

1. Before proceeding, eject disc(s) from factory unit if present.
2. Set parking brake and disconnect negative battery cable to prevent any electrical short.
3. Insert DIN tools into holes in each side of factory radio approximately one inch until a click is heard from each tool (Figure 1). **Note: Do not use excessive force** in order to prevent damage to retaining clips.
4. Spread tools apart slightly and pull out radio. Disconnect wiring harness, unplug antenna and remove radio (Figures 2 & 3).

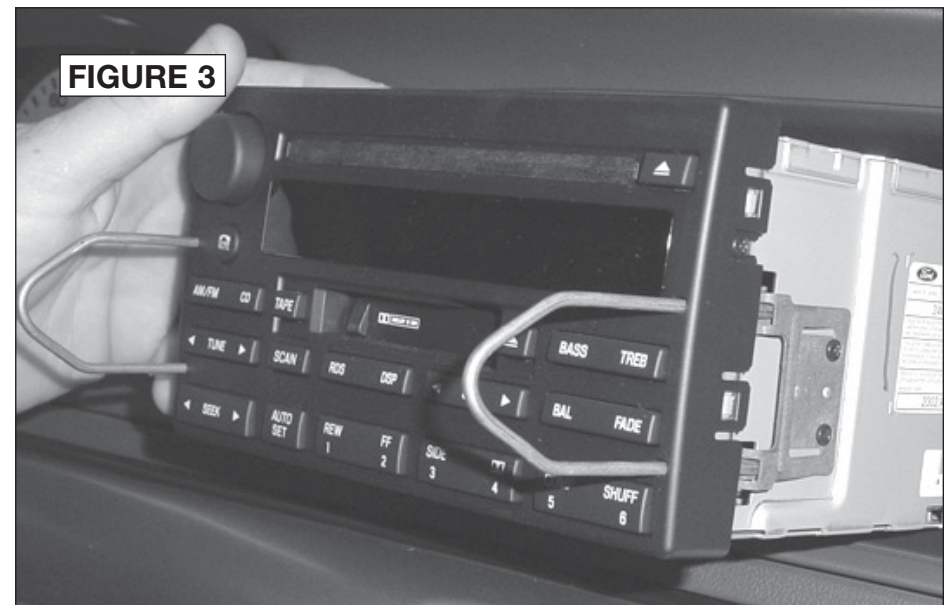
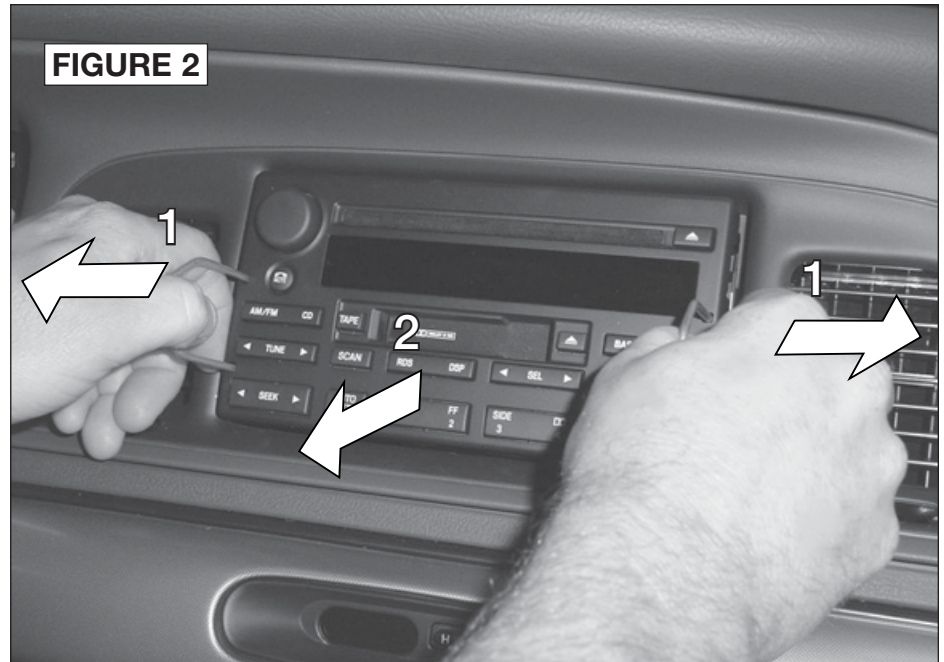

034 0021

# Receiver Installation

1. Secure receiver to mounting bracket following instructions supplied with the installation kit.
2. Connect receiver wiring adaptor to receiver following instructions supplied with adaptor.
3. Hold receiver assembly near dash. Connect receiver wiring adaptor to factory harness. Plug antenna lead into rear of receiver.
4. Slide assembly into dash until it snaps into place.
5. Test receiver operation.
6. Install DIN trim ring.

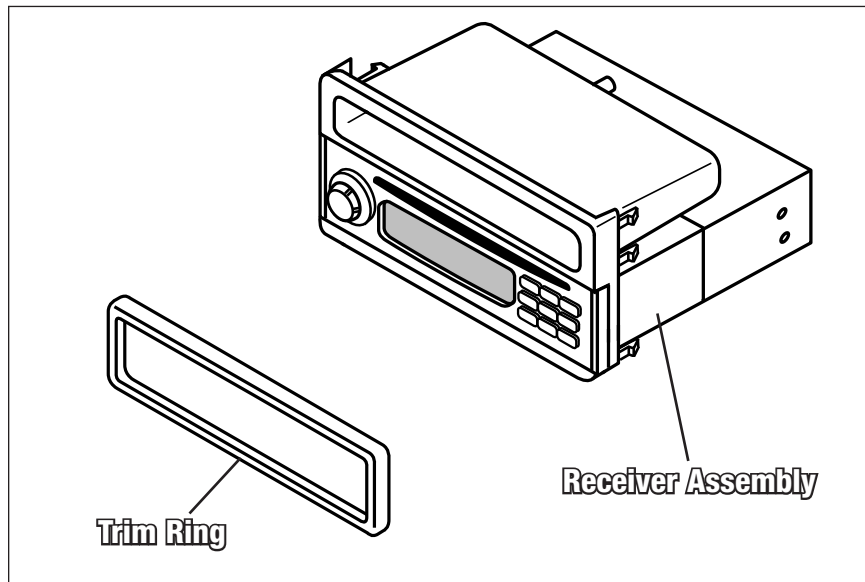

## NOTES:

### Please read first

- Inspect factory receiver harness connector in vehicle. Ensure that the wiring adaptor received from Crutchfield plugs into the vehicle's connector. If the connector is missing or incorrect, please call our **Technical Support Department** at **1-800-955-9094**.



1-800-955-9094  
TECHNICAL SUPPORT

**CRUTCHFIELD**<sup>®</sup>  
CRUTCHFIELD.COM

Copyright 2012 Crutchfield Corporation



034 0021

# Front Door Speakers

1. Pry out “sail” panel from the top edge to release one (1) clip. Lift panel to remove (Figure 1).
2. Pry out screw cover in center of door release trim. Remove one (1) Torx T30 screw (Figure 2).
3. Pry around front and side edges of power options switch panel to release. Lift panel, disconnect wiring harnesses and remove (Figures 3 & 4).
4. Remove one (1) 7mm screw from cavity exposed by removal of power options switch panel (Figure 5).

*Continued on the next page.*

## NOTES:

**Please read first**

- Instructions show factory size speakers or speakers with adaptor brackets only. Cutting or fabrication (not shown) will be required for other speaker sizes.

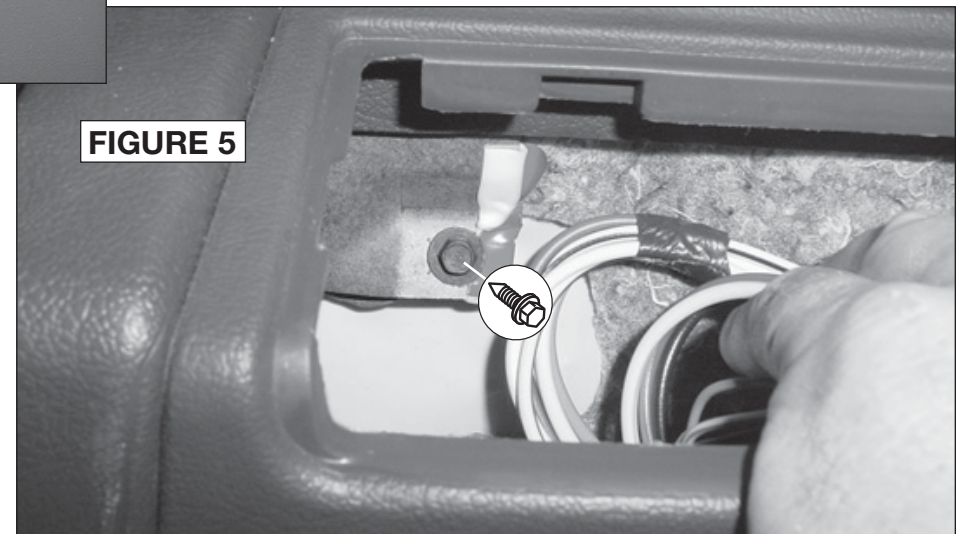
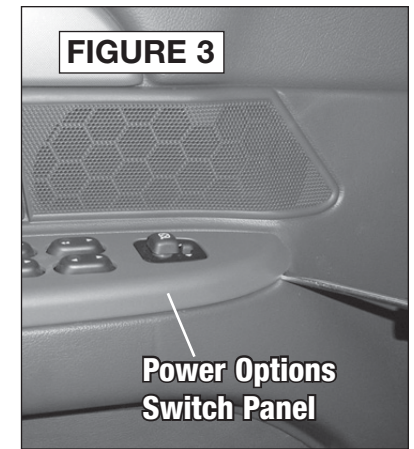
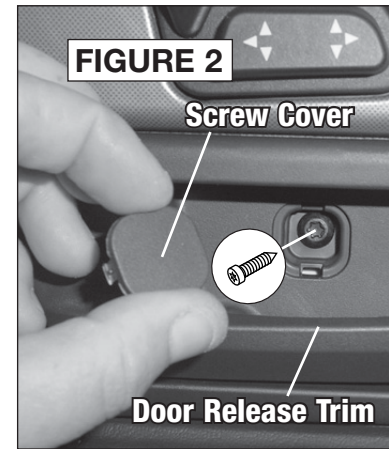
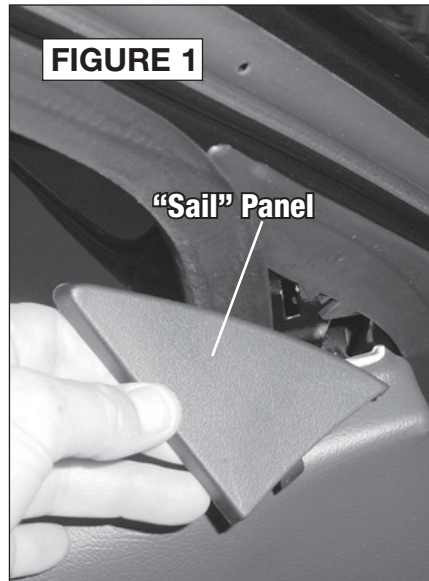

034 0021

## Front Door Speakers (continued)

5. Remove two (2) 7mm screws from bottom edge of door panel (Figures 6 & 7).
6. Lift door panel and disconnect wiring harnesses to remove (Figure 8).
7. Remove four (4) 5mm screws securing factory speaker. Pull out speaker, disconnect and remove (Figure 9).
8. Connect speaker wiring adaptor of replacement speaker to vehicle speaker harness. Secure new speaker with screws previously removed.
9. Test speaker operation and reinstall door panel by reversing removal steps.

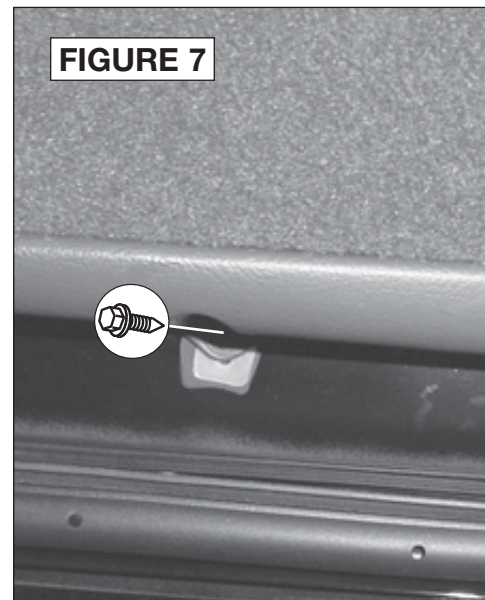
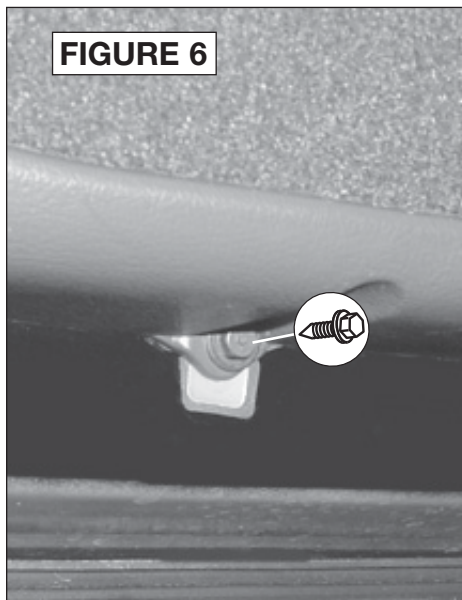
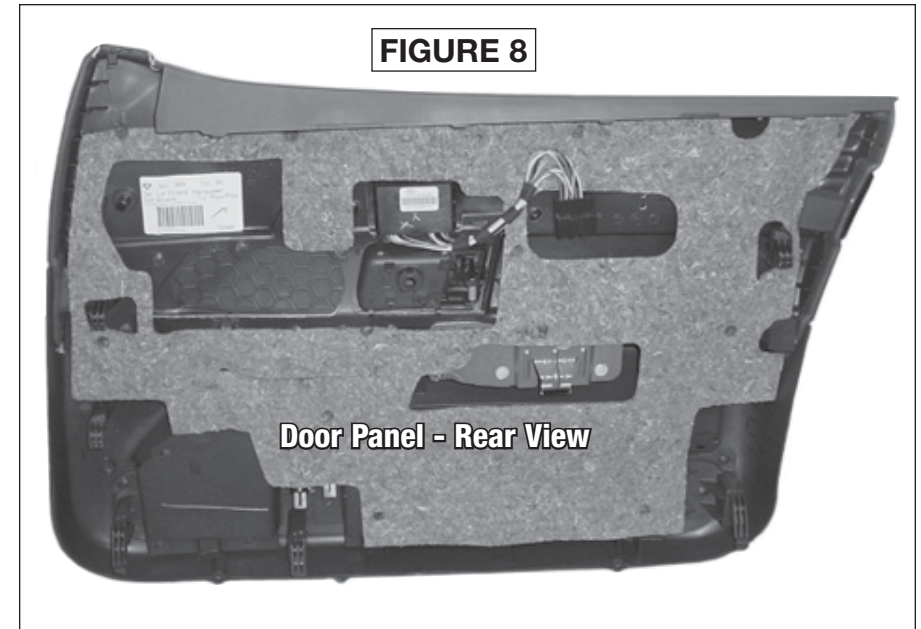



034 0021

## Rear Deck Speakers

1. Pry up edges of speaker grille to remove (Figure 1).
2. Remove four (4) phillips screws securing speaker. Pull out speaker, disconnect and remove (Figure 2).
3. Connect speaker wiring adaptor of replacement speaker to vehicle speaker harness. Secure speaker with screws previously removed.
4. Test speaker operation and reinstall grille.

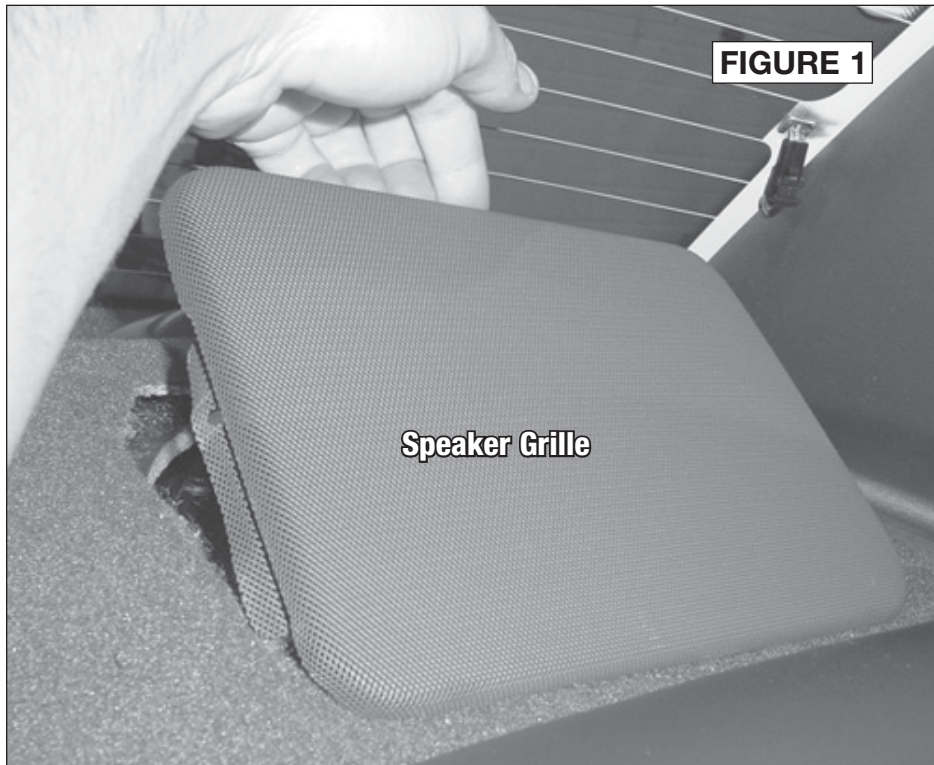

### NOTES:

#### *Please read first*

- Instructions show factory size speakers or speakers with adaptor brackets only. Cutting or fabrication (not shown) will be required for other speaker sizes.

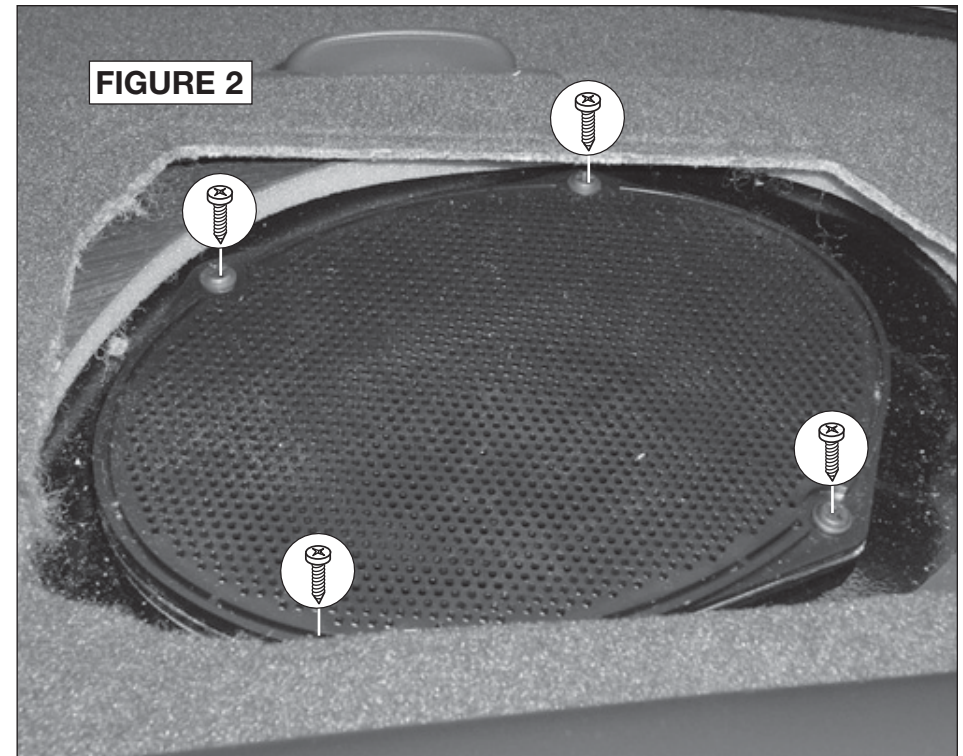

1-800-955-9094  
TECHNICAL SUPPORT

**CRUTCHFIELD**<sup>®</sup>  
CRUTCHFIELD.COM

Copyright 2012 Crutchfield Corporation



034 0021

## Rear Subwoofer

1. From the trunk, remove four (4) 12mm nuts securing sub enclosure. Disconnect wiring harness and remove enclosure (Figure 1).
2. Remove four (4) Torx T20 screws around foam area. Lift foam and remove. Pry speaker out of enclosure, disconnect speaker wires and remove speaker (Figures 2 & 3).
3. Connect factory speaker wires to replacement speaker. Secure speaker in the same manner as factory speaker with screws previously removed.
4. Test speaker operation and reinstall speaker enclosure by reversing removal steps.

